



## Yuasa Technical Data Sheet

### Yuasa M31-100S - Marine Batteries

#### Performance

Voltage	12V
Capacity (20-hour)	100Ah
Cold Cranking Amps (EN1)	750A

#### Dimensions

Length	330mm
Width	173mm
Height	240mm

#### Weights & Measures

Mean Weight with Acid	23.5kg
-----------------------	--------



#### Container Features

Case Type	GR31 BCI
Cell Layout	1
Hold Down	N
State of Charge Indicator	✓
Handles	✓
End Venting	✓
Semi-Traction Features	✓
Lid Type	SMF Double Lid

#### Technology

Flame Arrestor	✓
Technology	Ca/Ca
Separator	PE
Recommended Charge Rate	5A

#### Terminal Type

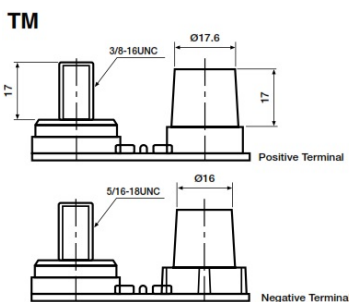

#### Cell Assembly Layout

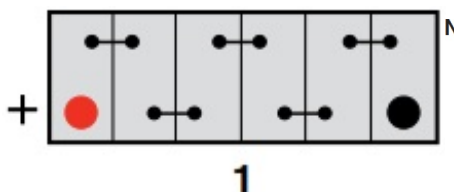

#### Battery Hold-down



Data Sheet generated on 08/07/2021 - E&OE